

# Moulinex®

## super uno

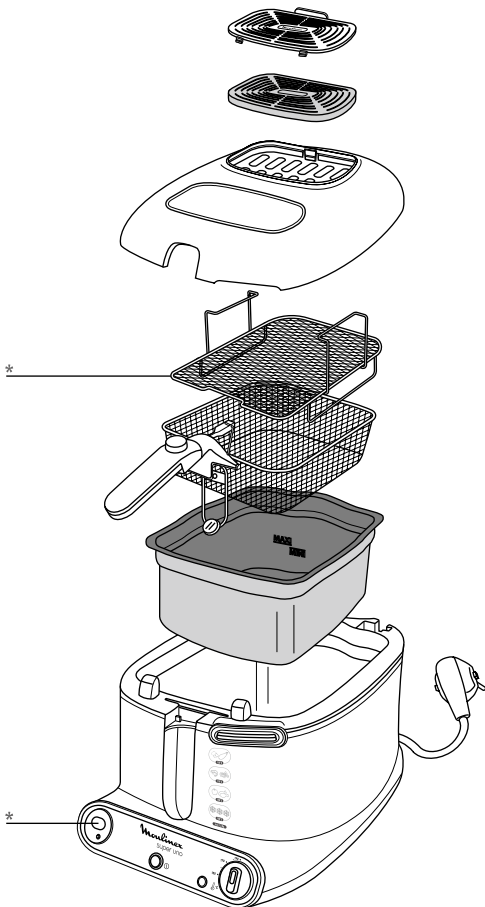



\* Selon modèle • Afhankelijk van het model • Je nach Modell • Depending on model • Secondo i modelli • Según modelo • Consoante o modelo • ανάλογα με το μοντέλο • Modelle göre • Afhængig af model • Beroende på modell • Avhenger av modell • Mallista riippuen • Ovisno o modelu • Zavisno od modela • в зависимости от модели • Odvisno od modela • W zależności od typu • Podle modelu • V závislosti od modelu • Modelltól függően • В зависимости от модели • Залежно від моделі • Ovisno o modelu • Sõltuvalt mudelist • Atbilstoši modelim • Pagal modelį • بحسب الموديل • بر حسب مدل

1

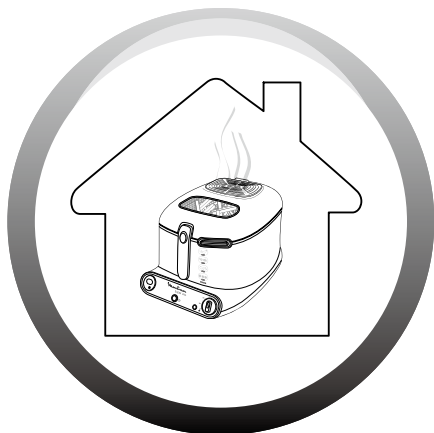

3

2

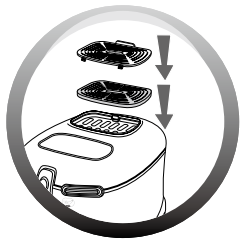
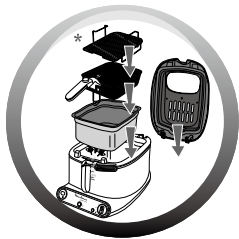
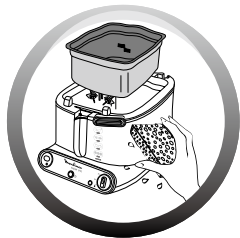
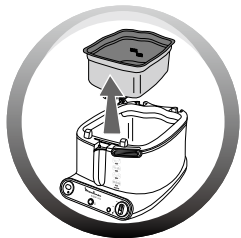
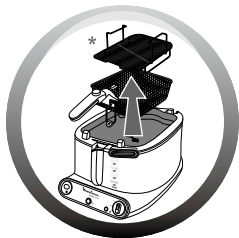
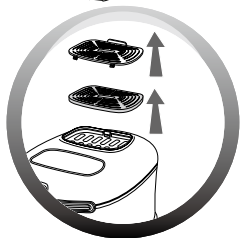
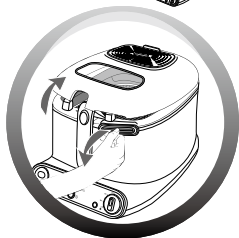

4

3



Min. 2 L / Max. 2,2 L

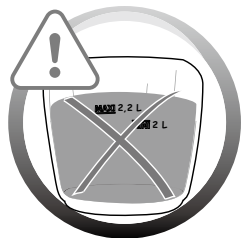
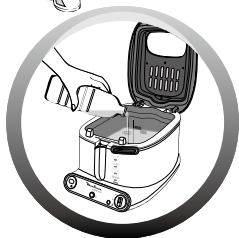

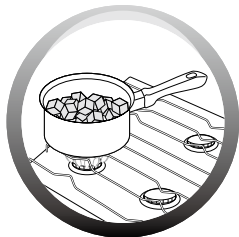



Max 1,3 Kg



700 g



Max 1 Kg



500 g

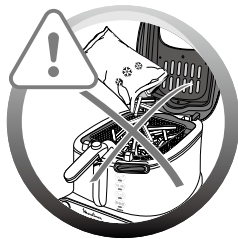
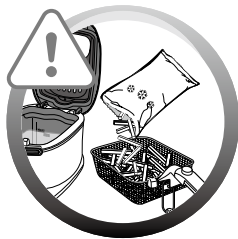



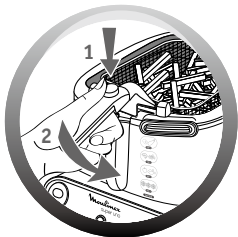
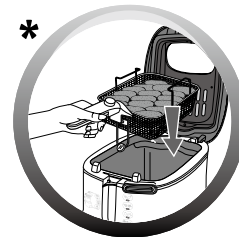
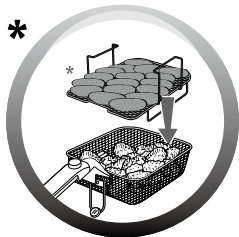
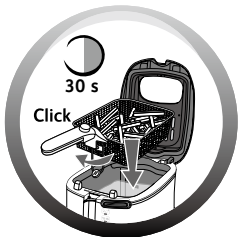
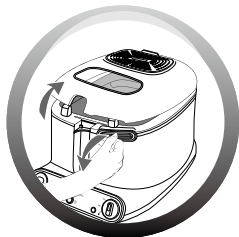
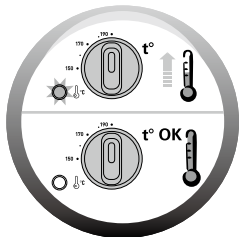
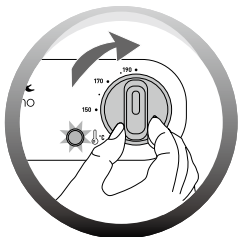
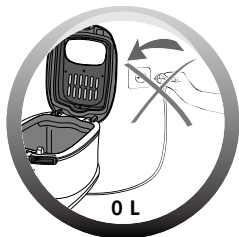
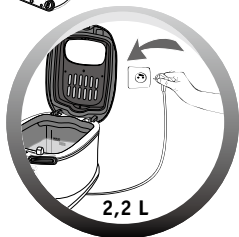

















6







					
					
	1,3 kg	170° C	20 - 22 min	-	-
	700 g	170° C	12 - 14 min	-	-
	1 kg	-	-	190° C	14 - 17 min
	500 g	-	-	190° C	6 - 9 min
	3 - 4 p	180° C	14 - 16 min	190° C	14 - 15 min
	1,5 kg	-	-	190° C	12 - 16 min
	2 p	170° C	6 - 8 min	190° C	6 - 7 min
	8 p	-	-	190° C	5 - 7 min
	8 - 10 p	170° C	5 - 6 min	190° C	4 - 5 min
	8 - 10 p	170° C	5 - 6 min	190° C	4 - 5 min
	6 p	190° C	2 - 3 min	-	-
	8 p	150° C	5 - 7 min	150° C	5 - 6 min
	4 p	180° C	5 - 6 min	-	-

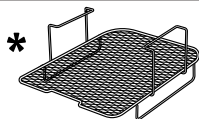

		2 p	190° C	6 - 7 min
		2 p		
		15 p	190° C	5 min
		15 p		
		12 p	190° C	5 min
		12 p		
		500 g	150° C	5 min
		500 g		
		18 p	190° C	4 min
		18 p		

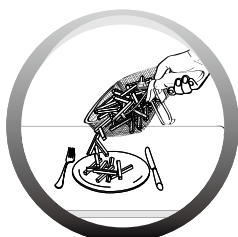
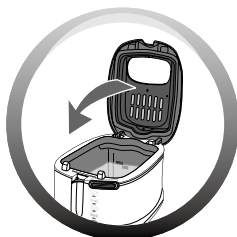
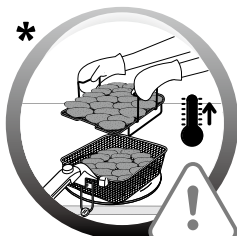
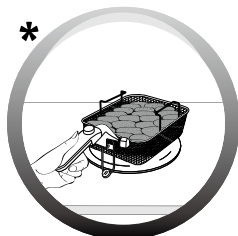
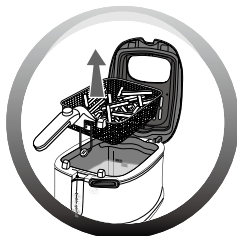
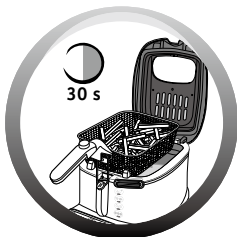
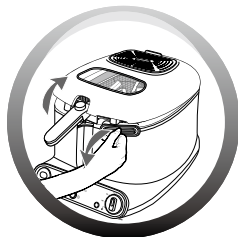
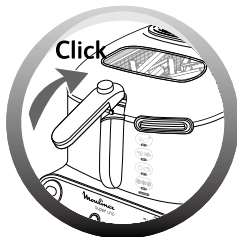
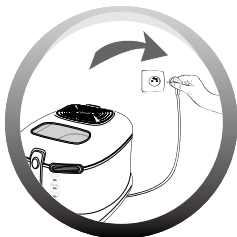
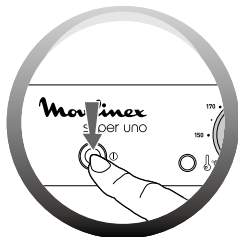
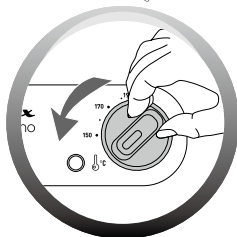

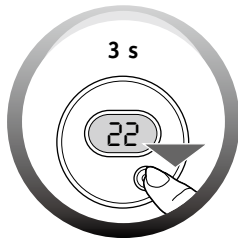
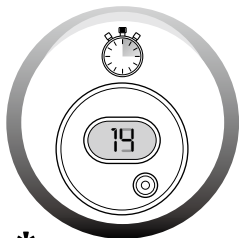
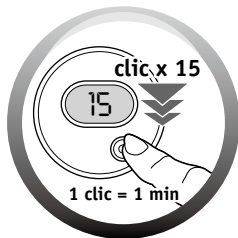
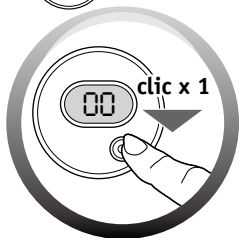
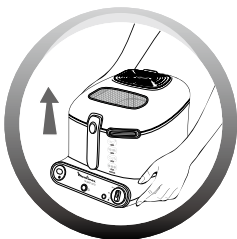
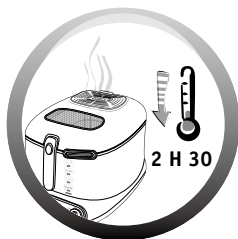

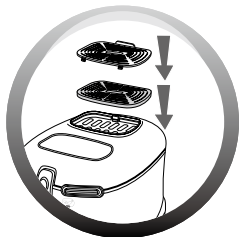
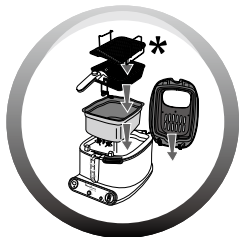
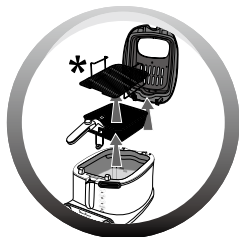
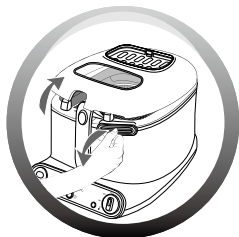
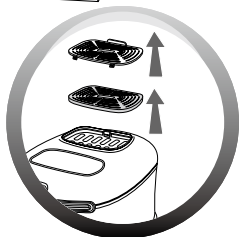

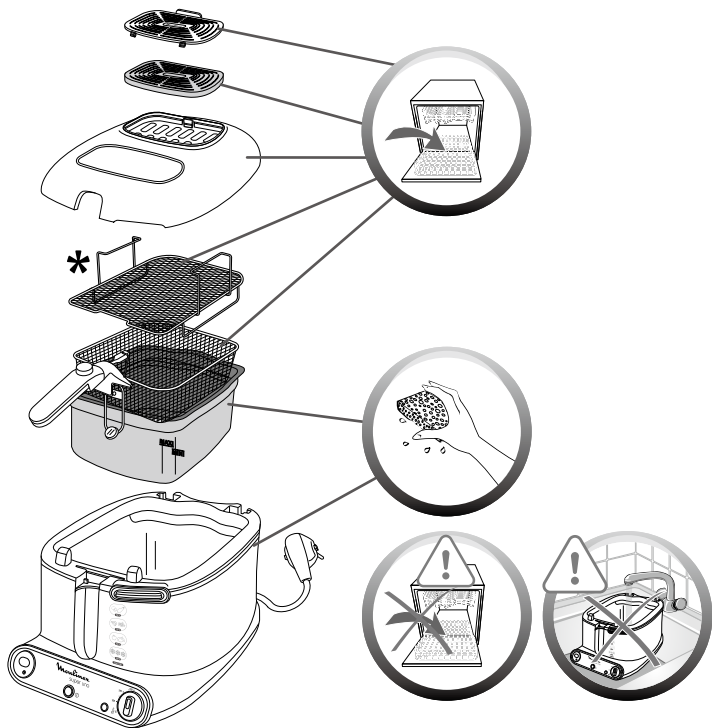

13



12 x

Max

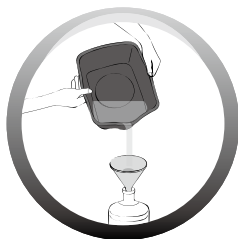
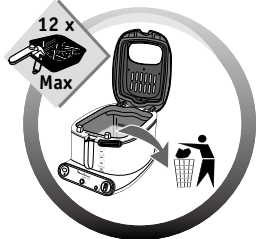

14



80 x

Max

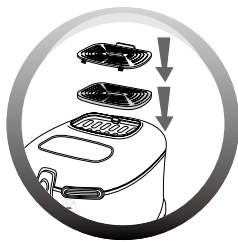
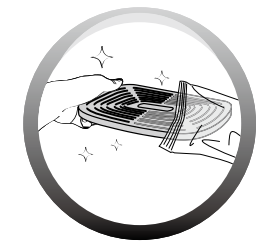
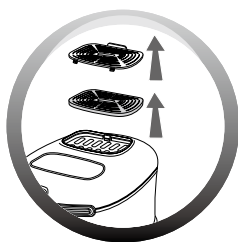
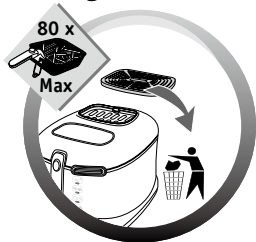



15

