

X8G *GYROSCOPE 2.4G* **EXPLORERS**

4CH 2.4G REMOTE CONTROL QUADCOPTER

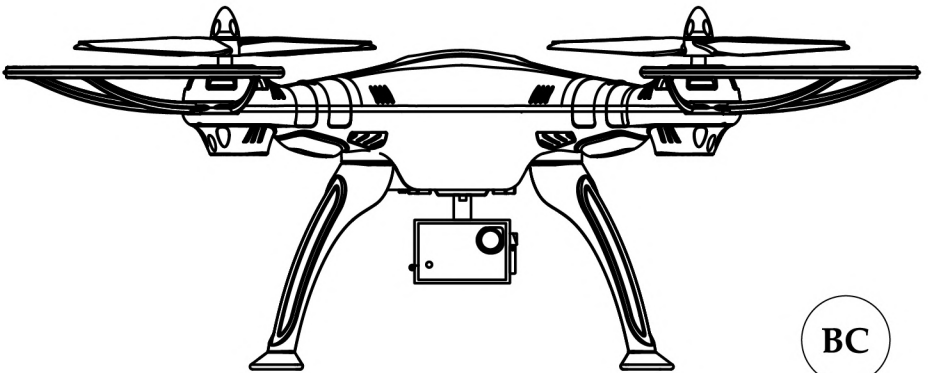

INSTRUCTION MANUAL

1

IMPLEMENT STANDARD: GB/T26701-2011

Main characteristics

- Four-axis structure is applied, which makes the quadcopter more flexible and rapid when flying. It has the characteristics of wind-resistant and can be flown indoor or outdoor.
- Built-in 6 axis gyroscope for precise hovering in the sky.
- Modular design structure is applied, more simple for assembly and convenient for maintenance.
- With 360° 3D eversion function and throwing flight function.
- Newly-increased headless function can recall the aircraft easily.

The materials and specification mentioned in this instruction manual or the parts inside this package is for reference only. Our company won't be responsible for any adaption of the outer package. Nor shall we keep our customers informed in advance. Any information updates or changes, please be subject to our website .

Safety regulations

1. Please put smaller parts of the quadcopter in the place where children can't reach, avoiding from accidents.
2. Power of this quadcopter is adequate. Therefore, when flying for the first time, it should push remote control's right/left variable-speed joystick slowly, avoiding from collisions caused by rising quadcopter rapidly.
3. After flying, please turn off the power of quadcopter and controller, also take out the batteries from controller.
4. Please don't put battery in high-temperature and heated places(such as fire or nearby electric heating devices).
5. When the quadcopter flies, it should maintain 2-3 meters from the user or others, avoiding from crashing into others' head, face or body when it lands.
6. When children operate the quadcopter, they should be accompanied with the adult and guided by the adult. Ensure that the quadcopter is controlled within the range of operator's (or instructor's) visibility. It is convenient for controlling.
7. Non-rechargeable battery can't charge. As installing or changing battery, please pay attention to the polarity. Don't use a mixture of old and new battery or battery with different types.
8. When it isn't used, it should turn off power supply of remote controller and quadcopter, respectively, and take out the battery in remote controller.
9. Power supply terminal can't be short circuit.

Maintenance

1. Use clean soft cloth to clean this product frequently.
2. Avoid from exposure or heating in the sun.
3. Don't put the toy in the water. Otherwise, it'll damage electronic parts.
4. Please check the plug and other accessories at regular intervals. If there is any damage, please stop using it immediately until it is repaired completely.

Contents

Product included following contents:

- Quadcopter
- 2.4G Remote controller
- Instruction manual
- Screwdriver
- Blade
- Power supply cable
- Battery
- Four riggers
- Four foot stands
- Card reader
- Screw(12)
- Camera hanger
- Camera
- Charge box
- Memory card



Get to know your transmitter

Introduction of transmitter:

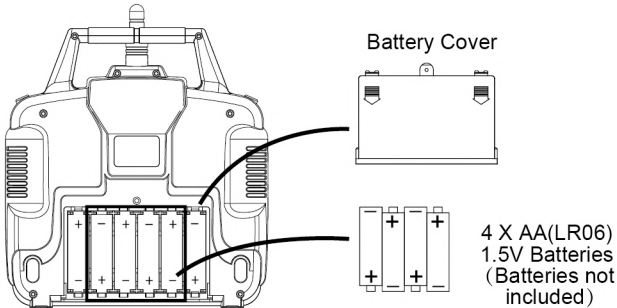
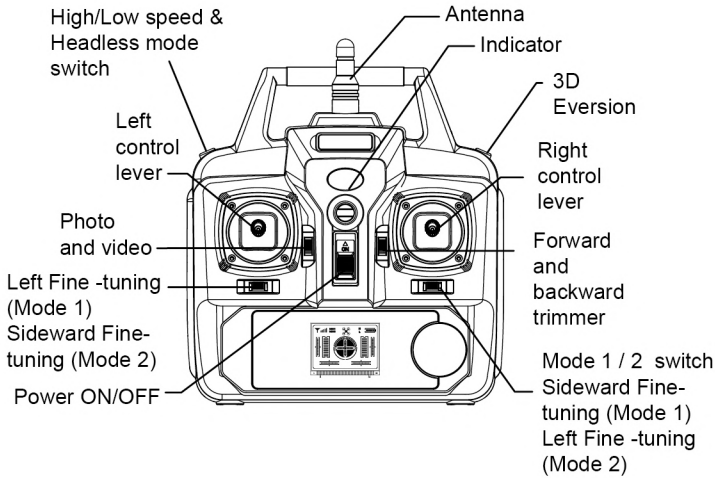

Installation methods of battery: Open back battery cover of remote control, and put 4 No.5 alkaline batteries in the middle place correctly, according to battery box's pole indication (battery should be available separately).



1. Install batteries with correct polarity.
2. Do not mix old and new batteries.
3. Do not mix different types of batteries.

Remote control keypad and lcd manual

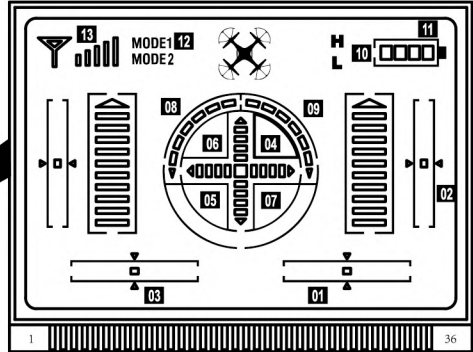
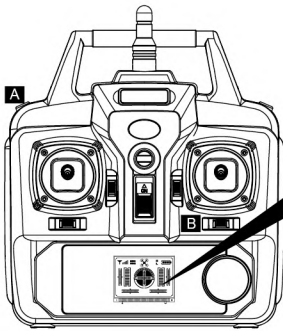

- 01.Sideward Fine-tuning :Power-on start in the centering.(Be turn Left/Right Fine-tuning in Mode2)
- 02.Forward/Backward fine-tuning:Power-on start in the middle.
- 03.Turn Left/Right fine-tuning:Power-on start in centering.(Be Sideward Fly Fine-tuning in Mode2)
- 04.Forward shows:Power-on start in the lowest level.(At the center square)
- 05.Backward shows:Power-on start in the lowest level.(At the center square)
- 06.Right sideward fly shows:Power-on start in the lowest level.(At the center square)
- 07.Left sideward fly shows:Power-on start in the lowest level.(At the center square)
- 08.Turn left: Pull left function lever to left, it will be higher, than quad copter turn left faster.
- 09.Turn right: Pull left function lever to right, it will be higher, than quadcopter turn right faster.
- 10.High/Low speed: Press button “A” for seconds to switch between high speed mode or low L speed mode. “H” means high speed and “L” means low speed.Headless Mode : Press button “A” for 3 seconds to enter headless mode or exit .
- 11.Power shows:According to the battery's energy for the controller.
- 12.MODE 1: Default mode when power-on.When change to MODE 2, please keep pressing button "B" to right than return on the power of transmitter, the MODE on LCD displayer will be changed. Same steps to change to MODE 1 again.
- 13.Signal shows:Normally to full frame.

Installation/disassembly steps for high-definition camera

Installation steps for high-definition camera:

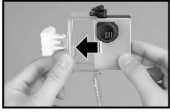

Figure (1)

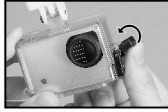

Figure (2)

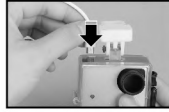

Figure (3)



Figure (4)



Figure (5)

1. Open camera hanger and put high-definition camera into the connector by aiming at hanger.
2. After putting high-definition camera into camera hanger, fasten the lock catch on the connector of camera hanger.
3. Insert power supply cable of high-definition camera into the socket of high-definition camera.
4. Push the high-definition camera to the top by aiming at the connector on the bottom of aircraft.
5. Insert power supply cable of high-definition camera into the connector on the bottom of aircraft.

Disassembly steps for high-definition camera:



Figure (1)



Figure (2)



Figure (3)



Figure (4)

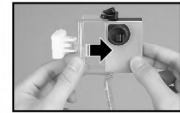

Figure (5)

1. Pull out power supply cable of high-definition camera from the connector on the bottom of aircraft.
2. Press and fasten safe lock of camera hanger, and pull out camera hanger outward.
3. Pull out power supply cable of high-definition camera.
4. Tear lock catch of camera hanger outward forcefully.
5. Take out high-definition camera from the hanger.

Note: After turning on power supply of aircraft, forbid to insert or pull out plug that connects to aircraft on high-definition camera.

Aerial photo function:

1. Methods: (1) Insert the cable plug of high-definition camera into specified socket of aircraft.

(2) Open aircraft power; after blinking red lamp on high-definition camera turns into green, it means that high-definition camera enters into normal working. After extinguishing red light and green light is not bright, either, it means that high-definition camera doesn't connect to memory card (SD card). If red light of memory card has been blinking, memory card may be stored full, and it needs to empty data.

2. Function introduction to photograph and video:

Photograph: when high-definition camera keeps in normal working, press "photograph/video", ring remote control for once, and flash red indicating light on high-definition camera, it refers to take a picture.

Video: When high-definition camera keeps in normal working, press "photograph/video", ring remote control for twice, red indicating light on the high-definition camera blinks continuously, it refers to be recording, press again, red light becomes green light, it refers to end video.

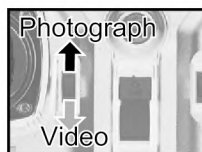

3. Camera has two modes of high definition (1080P) and smooth (720P) to switch.
4. When an aircraft is installed with aerial photo, please ensure that surface of high-definition lens is clean. If there is print, such as fingerprint, please wipe it out with cleaning cloth.
5. The recording video format of this HD camera is MOV format. Please use a player that supports for MOV format to pay this video document.

Installation steps of quadcopter's safety guard



Figure (1)



Figure (2)

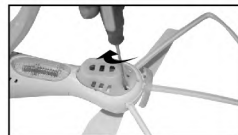
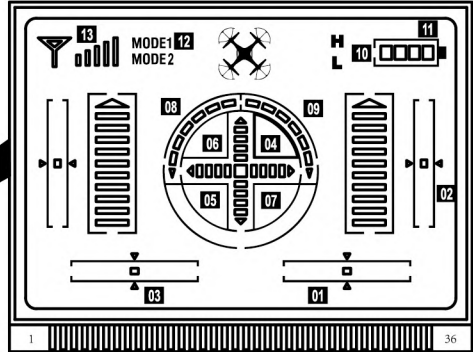
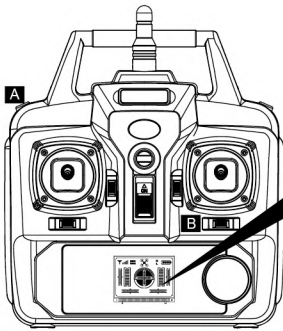

Figure (3)

1. Pull out decorating parts as shown in figure (1).
2. Press down decorating parts as shown in figure (2) and insert blade protective frame into fuselage interface.
3. Twist two screws of every parts as shown in figure (3).

Note: Without rigger, blade protective frame effect in flight will be better.

Remote control keypad and lcd manual



- 01.Sideward Fine-tuning :Power-on start in the centering.(Be turn Left/Right Fine-tuning in Mode2)
- 02.Forward/Backward fine-tuning:Power-on start in the middle.
- 03.Turn Left/Right fine-tuning:Power-on start in centering.(Be Sideward Fly Fine-tuning in Mode2)
- 04.Forward shows:Power-on start in the lowest level.(At the center square)
- 05.Backward shows:Power-on start in the lowest level.(At the center square)
- 06.Right sideward fly shows:Power-on start in the lowest level.(At the center square)
- 07.Left sideward fly shows:Power-on start in the lowest level.(At the center square)
- 08.Turn left: Pull left function lever to left, it will be higher, than quad copter turn left faster.
- 09.Turn right: Pull left function lever to right, it will be higher, than quadcopter turn right faster.
- 10.High/Low speed: Press button “A” for seconds to switch between high speed mode or low speed mode. “H” means high speed and “L” means low speed.Headless Mode : Press button “A” for 3 seconds to enter headless mode or exit .
- 11.Power shows:According to the battery's energy for the controller.
- 12.MODE 1: Default mode when power-on.When change to MODE 2, please keep pressing button "B" to right than return on the power of transmitter, the MODE on LCD displayer will be changed. Same steps to change to MODE 1 again.
- 13.Signal shows:Normally to full frame.

Installation steps of quadcopter's stands

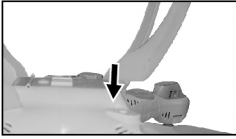

Figure (1)

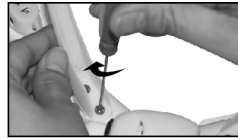
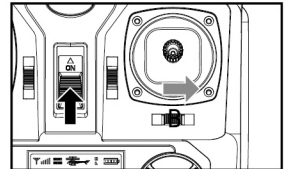

Figure (2)

1. Insert stands into the quadcopter body as figure(1).
2. Twist the wide screws to locking the stands as figure(2).

Controller modes & instructions

The transmitter built-in two modes, Mode 1 & Mode 2, in line with different customer's usage pattern. Keep pushing button B to right, then turn on the transmitter power to change Mode 1 or Mode 2.



MODE 1

Operating direction

Hover up and down

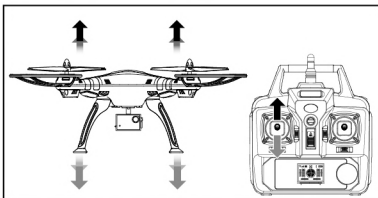

Push the throttle up or down, the quadcopter flies upward or downward.

Forward and backward

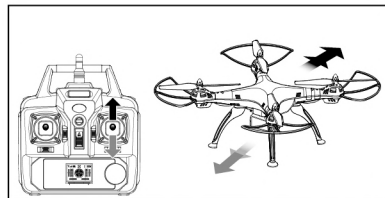

Push the direction lever up or down, the quadcopter flies forward or backward.

Turn Left and Right

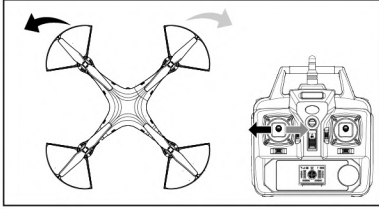

Pull the throttle left or right, the quadcopter turns to left or right.

Sideward fly

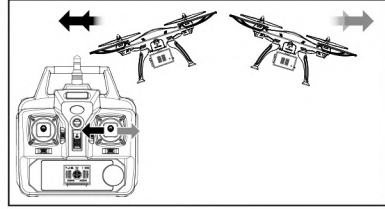

Pull the direction lever left or right, the quadcopter flies to left side or right side.

Fine-tuning operation

Forward/Backward fine-tuning

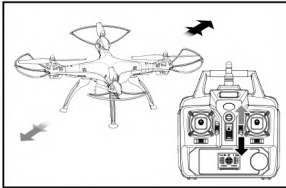

When the quadcopter keeps flying forward / backward, you can correct it by pressing the fine-tuning button down / up.

Sideward fly fine-tuning

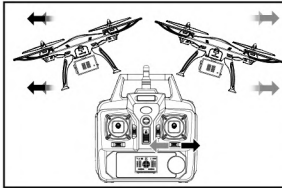

When the quadcopter keeps flying to left / right side, you can correct it by pressing the fine-tuning button right / left.

Turn left/right fine-tuning

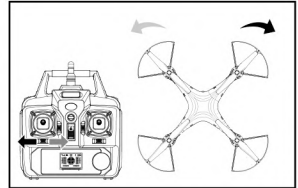

When the quadcopter keeps rotating to left / right, you can correct it by pressing the fine-tuning button right / left.

MODE 2

Operating direction

Hover up and down

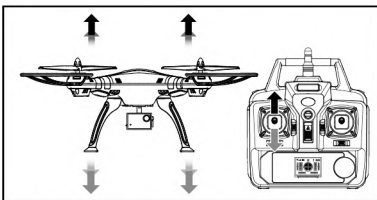

Push the throttle up or down, the quadcopter flies upward or downward.

Forward and backward

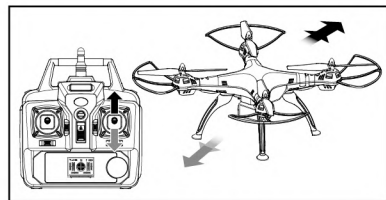

Push the direction lever up or down, the quadcopter flies forward or backward.

Turn Left and Right

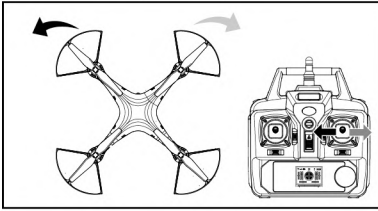

Pull the direction lever left or right, the quadcopter turns to left or right.

Sideward fly

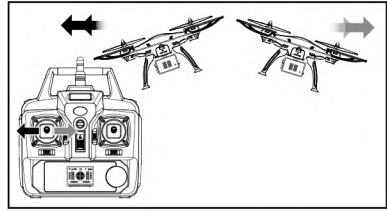

Pull the throttle left or right, the quadcopter flies to left side or right side.

Fine-tuning operation

Forward/Backward fine-tuning

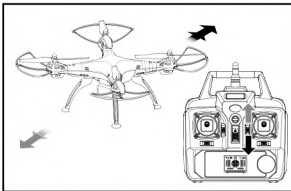

When the quadcopter keeps flying forward / backward, you can correct it by pressing fine-tuning button down / up.

Sideward fly fine-tuning

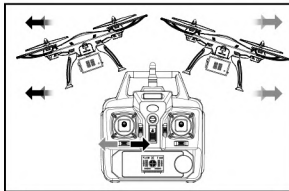

When the quadcopter keeps flying to left / right side, you can correct it by pressing the fine-tuning button right / left.

Turn left/right fine-tuning

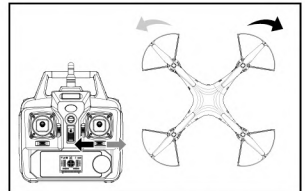

When the quadcopter keeps rotating to left / right, you can correct it by pressing the fine-tuning button right / left.

Ready to fly your quadcopter

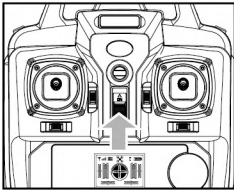

1. Press the ON/OFF power switch up.

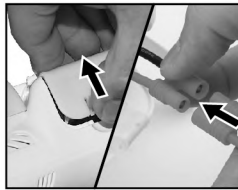

2. Open battery cover, and connect battery connector with dash receiver.

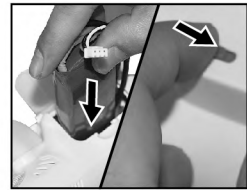

3. Enclose battery into the fuselage, after closing battery cover, turn on the switch on the bottom of aircraft.

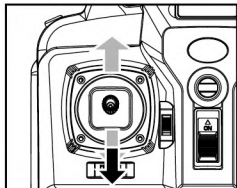

4. Push the throttle lever to the highest position, and then pull it back to the lowest position. There will be one clear sound from the transmitter, this shows that the quadcopter has entered into the pre-fly state.

Function introduction

1. Low-voltage protection:

If four indicator lights in the bottom of aircraft start to twinkle, it means that the aircraft is short of electricity and is not able to roll. At that time, a return voyage shall immediately be made to the aircraft.

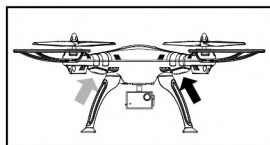

2. Over-current protection:

In the condition of rotating aircraft's fan blade, when being crashed or stuck, aircraft's circuit will conduct over-current protection.

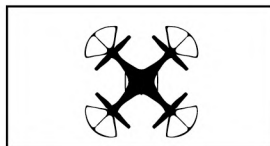

3. Horizontal correcting function:

Place the quadcopter on a horizontal position, then push transmitter both left and right lever to lowest right corner for about 2-3 second, indicator on the quadcopter changed from normal lights up to quickly flashing; After 2-3 second, the indicator changed to normal lights, it means the quadcopter restarted /reset successfully.

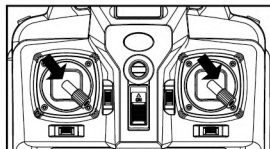

4. 3D eversion:

When you are familiar with the basic operation, you can do some awesome & exciting tricks and stunts! First of all, fly the aircraft to a height of more than 3 meters, press the 3D Eversion switch on the rear right side of the transmitter, then push the right rudder (in any direction) to make 360 degree flip.

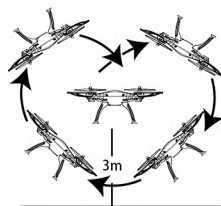

Suggestion: in order to realize stability of camera components, when mounting camera, it's better not to roll.

5. Headless function:

1. Forward definition

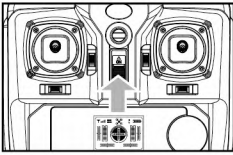

1. Turn on power switch of remote control.

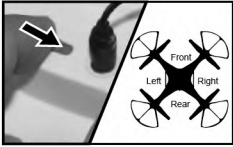

2. After aircraft connects with power supply, place the switch in "ON" position, adjust the direction pointed by aircraft's handpiece and regard it as the dead ahead in headless situation.

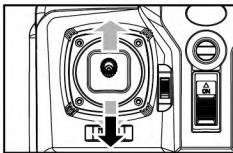

3. Push the accelerator's push rod of remote control to the highest point and pull back to the lowest point. When remote control pops, it indicates that frequency modulation and forward definition have already finished.

2. Switch to headless function and general function

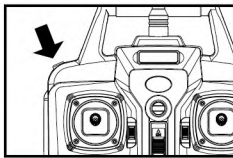

1. After frequency modulation, the aircraft defaults to general pattern. The indicator light on aircraft is long bright state. After pressing down headless function switch on the top left of master remote controller for 2 seconds, remote control will give out "DDD...", it means that it enters into headless state. After pressing for 2 seconds and hearing long "D", it means that it exits headless state. (In headless mode, four indicators on the aircraft flicker slowly for once within four seconds)

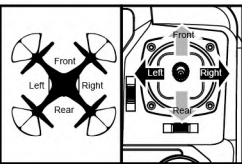

2. In headless state, the operator has no need to recognize the position of aircraft's headpiece, and he just needs to control the aircraft in accordance with the direction of remote control's operating rod.

3. Correcting forward direction

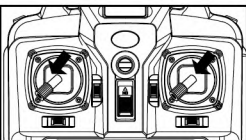

1. When the aircraft is in the headless condition, if there is any deviation in the fixed-head direction, it is necessary to re-fix the right direction of the aircraft and stir the accelerator and direction lever to the bottom left side. Long-time shining of indicator lights on the aircraft after slow flashing for 3 seconds shows that adjustment is completed.

Battery replacement and charging method

Steps of battery replacement:

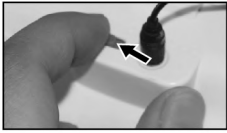

Figure (1)

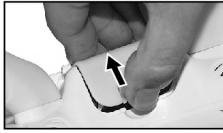

Figure (2)

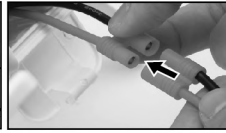

Figure (3)

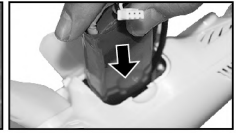

Figure (4)

1. Turn off aircraft's power supply, and push the switch to "OFF" Figure (1).
2. Open aircraft's battery cover backward Figure (2).
3. Connect battery interface with dash receiver Figure (3).
4. After battery replacement, fasten the battery cover again Figure (4).

Steps of battery charge:

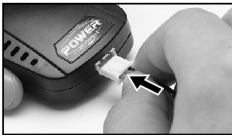

Figure (1)



Figure (2)

1. Connect battery switch with charger Figure (1).
2. Connect charger to power supply socket Figure (2).

Balanced charger:

1. Insert adapter's DC outlet into import socket of balanced charger. Red light of balanced charger will light on.
2. Insert three-position balanced plug of power battery to output end of charger. Green light of balanced charger will light on. When green light extinguishes, it means the end of battery charging. (Charging time is less than 200 minutes)

Note: if power battery inserts into the charger, the light has no change. It indicates that this battery is full energy. There is no need to recharge.

Charging time: about 200 minutes Flying time: about 7 minutes!

Cautions when charging:

1. When charging, please put this product on a dried or ventilated area and keep it far away from heat source or explosive product.
2. When charging, please remove the batteries from the quadcopter. Then charging process should be supervised by an adult so as not to cause an accident.
3. When finish flying, please do not charge the battery if the surface temperature is still not cool. Otherwise it may cause a swollen battery or even a fire hazard.
4. Please make sure that you use the original USB charging cable provided. When the battery has been used for a long time, or appears to be swollen, please replace them.
5. A battery when not in use for a long time will lose its charge automatically. Charging or discharging too often may reduce the life of the battery.

Steps of fan blade's installation/disassembly of aircraft

Steps of fan blade's disassembly:



Figure (1)



Figure (2)

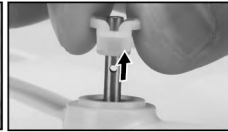

Figure (3)



Figure (4)

1. Rotate and back out fan blade cover in anti-clockwise direction as shown in Figure (1) .
2. Rotate blade lockstitch for about 90° in the anti-clockwise as Figure(2) till the iron shaft point to the opening of blade lockstitch.
3. Get iron shaft out and pull blade lockstitch upward as Figure (3) shows.
4. Pull out fan blade upward as shown in Figure (4) .

Installation steps of fan blade:



Figure (1)



Figure (2)



Figure (3)



Figure (4)

1. Insert fan blade into principal axis pipe as shown in Figure (1).
2. Install the blade lockstitch inside the quill as Figure (2) shows to ensure that the gap of blade lockstitch aligns at the hole on the quill.
3. Install the iron shaft inside and rotate blade lockstitch for about ninety degrees in the clockwise direction shown in Figure (3).
4. Rotate and twist fan blade cover in clockwise direction as shown in Figure (4).

Maintenance procedure

Problems	Causes	Solutions
Aircraft has no response	<ol style="list-style-type: none"> 1. Aircraft enters into low-voltage protection. 2. Electric quantity of remote control is insufficient, power indicator light will flicker. 3. Channel selection of remote control is inconsistent with aircraft's match codes. 	<ol style="list-style-type: none"> 1. Charge the aircraft. 2. Change remote control's battery. 3. Adjust channels of remote control and aircraft, and make them become consistent.
Aircraft's flying response is insensitive	<ol style="list-style-type: none"> 1. The remote-control unit suffers low battery or the quality of battery is not good enough. 2. Remote control with the same frequency is transmitting interference. 	<ol style="list-style-type: none"> 1. Change battery with better quality. 2. Change the place where has no transmitting interference of the same frequency.
When hovering, side flight is formed	<ol style="list-style-type: none"> 1. Have no horizontal correction. 	<ol style="list-style-type: none"> 1. Conduct horizontal correction, as shown in p.9(3)(correcting function).
In headless state, it deviates to dead ahead	<ol style="list-style-type: none"> 1. Head deflection is caused by multiple collisions. 2. Long time usage of headless mode. 	<ol style="list-style-type: none"> 1. Define forward again, as shown in p.10(5)(headless function).

Spare parts

Here are alternative accessories. In order to provide convenience for customer purchasing, every component are marked. Accessories can be purchased from local dealer. Please specify the color when purchasing.



X8G-01

Upper body(Silver)



X8G-02

Lower body(Silver)



X8G-03

Landing skids(Black)

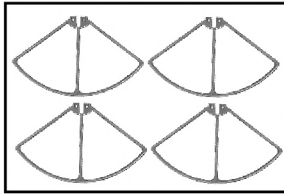

X8G-04

Protecting frames(Black)

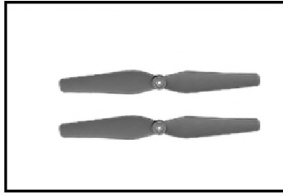

X8G-05

Rotating blades (Black)

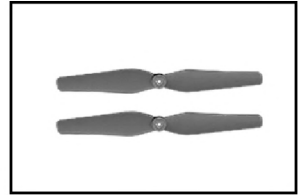

X8G-06

Reversing blades (Black)

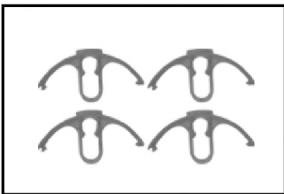

X8G-07

Ornament part(Black)

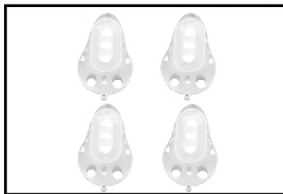

X8G-08

Motor holder(Silver)

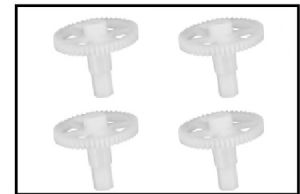

X8G-09

Gear



X8G-10

Motor A



X8G-11

Motor B



X8G-12

Main stand

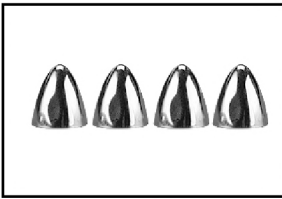

X8G-13
Blade cover

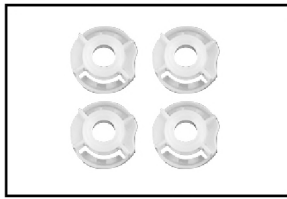

X8G-14
Blade lockstitch

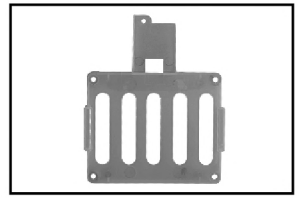

X8G-15
Base of Dash Receiver
(Black)



X8G-16
Battery cover(Silver)

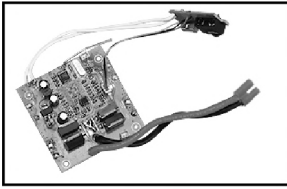

X8G-17
Receiver board

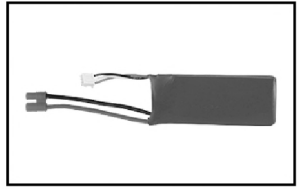

X8G-18
Battery



X8G-19
A/B adaptor&charge box

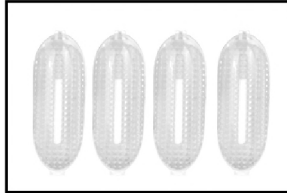

X8G-20
Lampshades



X8G-21
Transmitter



X8G-22
Camera



X8G-23
Camera hanger

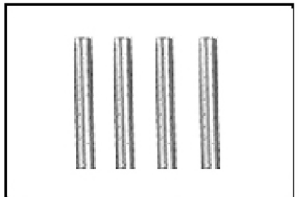

X8G-24
Iron shaft



X8G-25
Reader

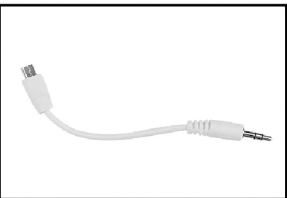

X8G-26
Power supply cable

Brekdown&Diagram

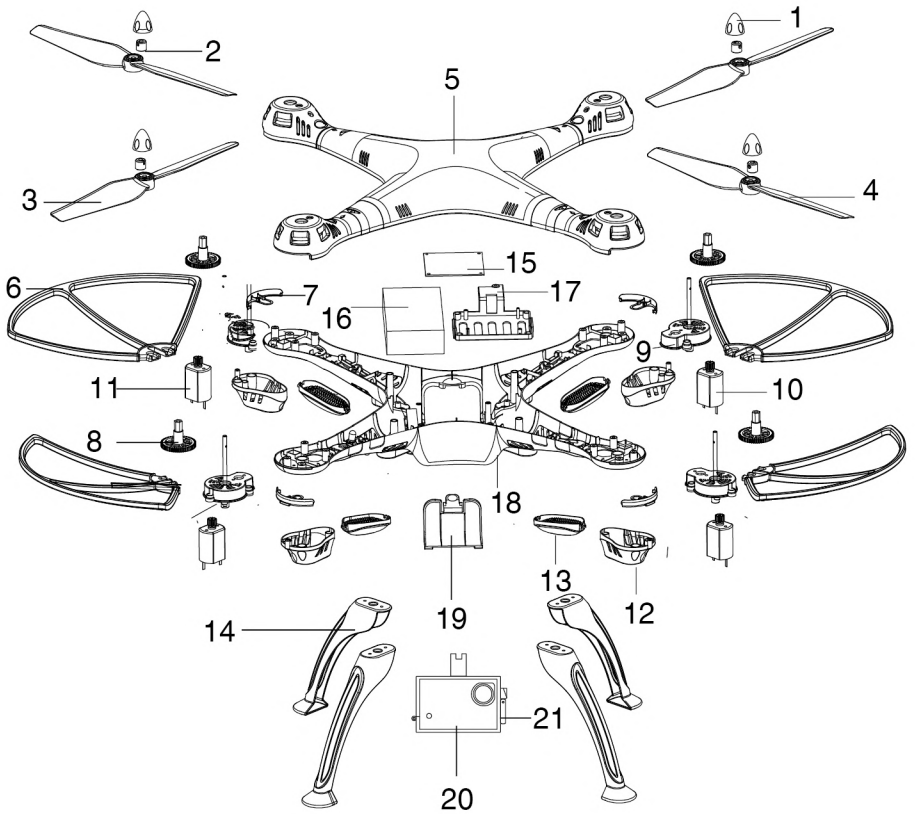

Code	Description	Quantity	Code	Description	Quantity	Code	Description	Quantity
1	Blade cover	4	8	Cear	4	15	Receiver board	1
2	Blade lockstitch	4	9	Main stand	4	16	Battery	1
3	Reversing blades	2	10	Reversing motor	2	17	Base of Dash Receiver	1
4	Rotating blades	2	11	Rotating motor	2	18	Lower body	1
5	Upper body	1	12	Motor cover	4	19	Battery cover	1
6	Protecting frames	4	13	Light boards	4	20	Camera	1
7	Ornament part	4	14	Landing skids	4	21	Camera hanger	1

Main parameter

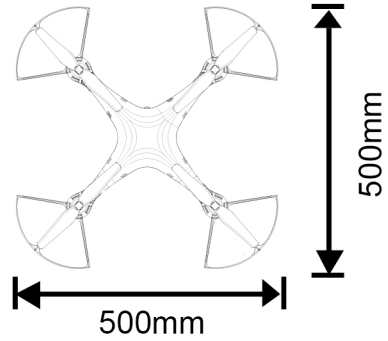
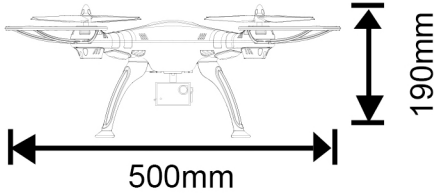

Length of fuselage:500mm

Width of fuselage:500mm

Height of fuselage: 190mm

Code of main engine:132

Battery:7.4V 2000mAh



SPECIFICATIONS AND COLORS OF CONTENTS MAY VARY FROM PHOTO.

The company has the right of final interpretation
of this instruction manual statement.